



SCSI cable LVD-SE VHDCI to HP-DB68, metal plugs, 2m

item no. **CS-VH-020-M**



Special SCSI cable with VHDCI male (small plug, 68pin) to HP-DB68 male (68pin), 2m, High End UL cable material, metal plugs with screws, e.g. for data acquisition cards, LVD 320 MByte/s or WIDE-SCSI

key features

- LVD cable premium quality
- VHDCI-68 plug to HP-DSub-68 plug
- metal plugs (AMP)
- Madison cables
- for 4 port controller (e.g. Adaptec, IBM, Mylex)
- ultra-320 speed up to 320 MByte/s
- double shield, twisted pairs
- plugs with strain relief
- length 2m

Available downloads:

- [Data sheet](#)



VHDCI

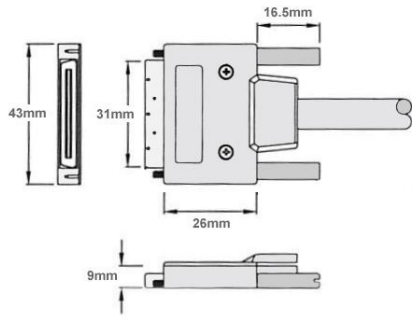

HP-DSub-68

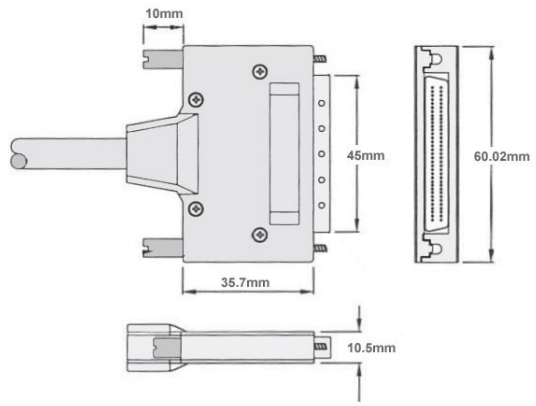

VHDCI
68 PIN male

HP-DSub-68
68 PIN male

